

DO GRC

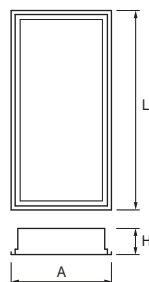

DO GRC 10 O / P

Tª Amb	L	A	H	Kg
< +35°C	1197	297	90	6,30

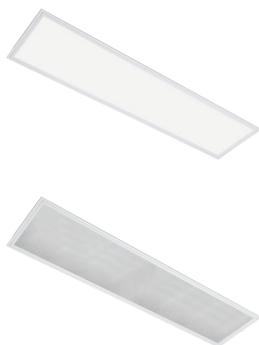

DO GRC 20 O / P

Tª Amb	L	A	H	Kg
< +35°C	597	597	90	6,50

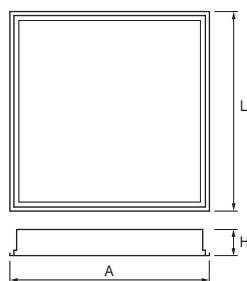
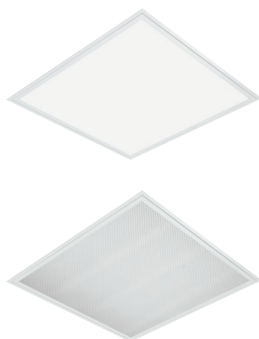

Antes de proceder al montaje, ¡desconecte la corriente eléctrica! La luminaria ha de ser conectada solamente por la persona que posee la calificación adecuada. La luminaria ha de ser conectada solamente en conformidad con las normas electrotécnicas correspondientes. En caso que el producto fuera modificado o instalado incorrectamente, el fabricante no asume responsabilidad alguna.

Turn off the power prior to light fixture installation!. The light fixture may be installed only by a qualified person!.The light fixture must be wired according to respective electrical standards. Use protective gloves when handling the reflective part!. The manufacturer shall not be liable for any modifications or incorrect installation of the product.



Luminaria empotrada adecuada para el montaje en superficie normalmente inflamable. Bajo ninguna circunstancia, la luminaria debe cubrirse con material aislante o similar.

Recessed luminaire suitable for mounting on flammable surfaces. Under no circumstances, the luminaire should be covered with insulating material or similar.

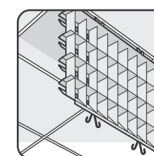

Al montar el difusor los brazos del muelle deben entrar juntos en uno de los dos agujeros del chasis.

Los difusores se abaten sobre uno de los laterales, quedando suspendidos del bastidor por dos muelles, para más seguridad de sujeción; operación que puede ser realizada perfectamente por una sola persona.

Fixing Diffuser: Both arms of the spring are inserted in either one of the openings in the chassis.

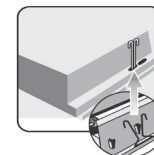

The diffuser folds down to one side and is suspended from the frame by two springs. This operation is very simple and can be carried out by one person.

Esquema eléctrico Electric diagram

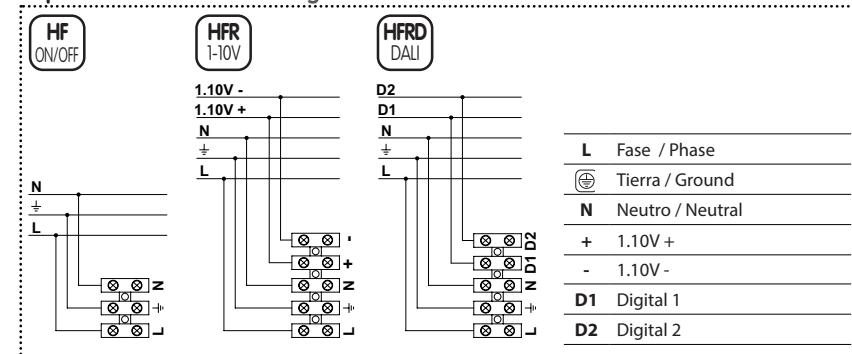

Instrucciones de montaje

Installation instructions

Montaje en techo de escayola mediante garras de acero.
Plasterboard ceiling mounting. The luminaire stays in place by means of the fixing brackets.

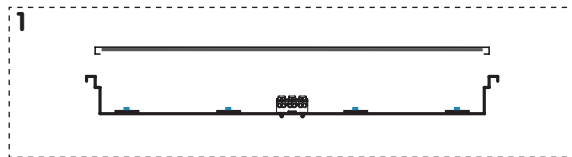
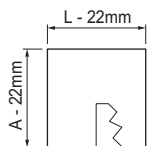

1
Desmontar el difusor por medio de los muelles.
Disassemble the diffuser by means of springs.

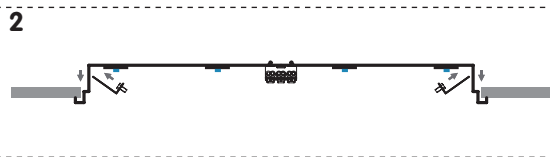

2
Instalar la luminaria por medio de las garras de acero.
Install the luminaire by means of steel brackets.

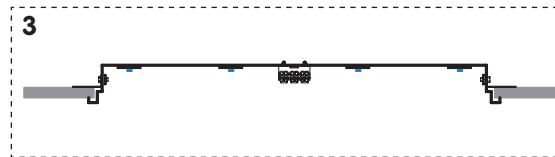

3
Apretar las tuercas de las garras de acero.
Tighten the nuts of steel brackets.

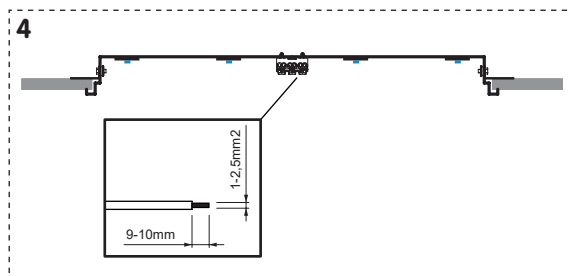

4
Conectar el cable de alimentación. Ver esquema de conexión.
Connect feed cable. See electric diagram.

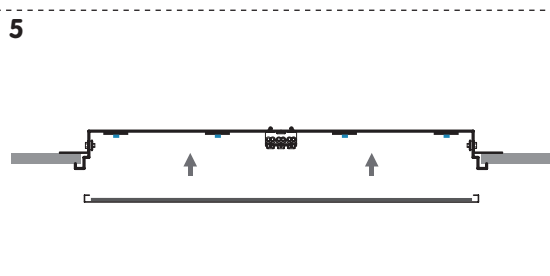

5
Montar el difusor por medio de los muelles.
Assemble the diffuser by means of springs.

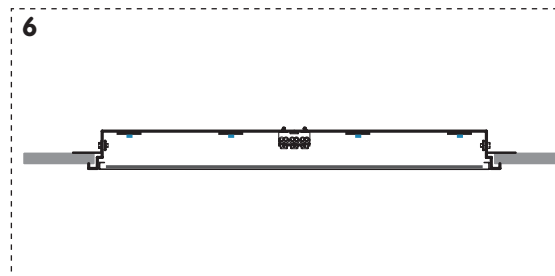

Montaje en techo modular perfil visto.
Modular ceiling with exposed T-bar mounting.

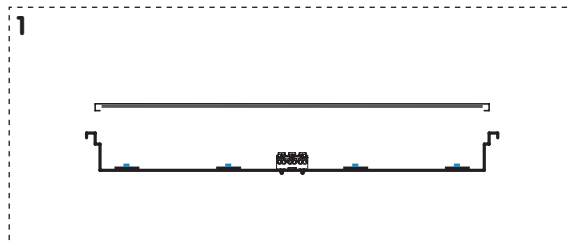

1
Desmontar el difusor por medio de los muelles.
Disassemble the diffuser by means of springs.

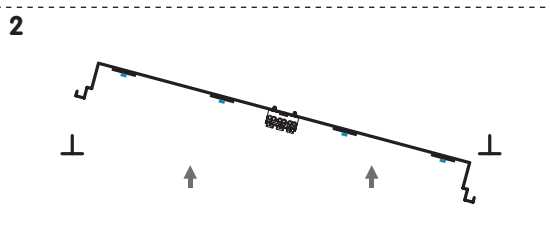

2
Instalar la luminaria en el techo perfil visto.
Install the luminaire on the T-bar ceiling.

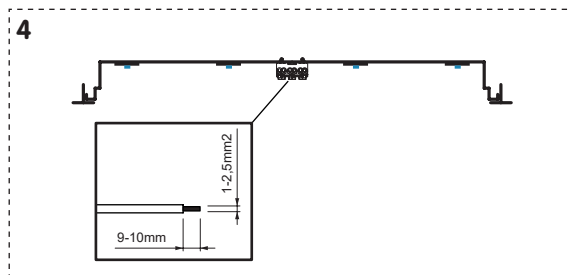
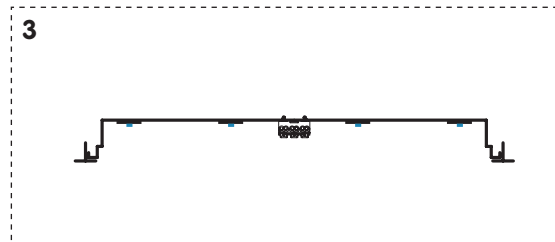

4
Conectar el cable de alimentación. Ver esquema de conexión.
Connect feed cable. See electric diagram.

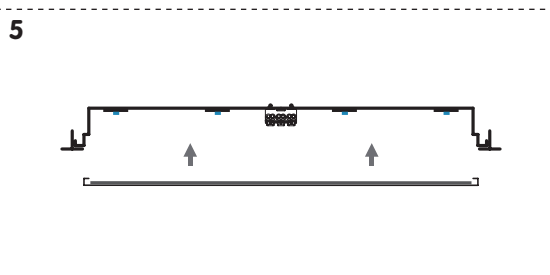

5
Montar el difusor por medio de los muelles.
Assemble the diffuser by means of springs.

