

R3 PTR LED 54 (RA / RM)

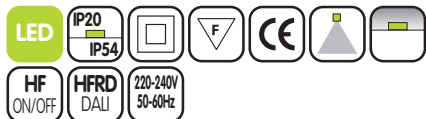

R3 PTR 54 LED 0

W	T° Amb	Ø D	H	Kg
8	-20°C +35°C	116	76	0,60
11	-20°C +35°C	116	76	0,60



R3 PTR 54 LED 1

W	T° Amb	Ø D	H	Kg
15	-20°C +35°C	166	113	0,80
20	-20°C +35°C	166	113	0,80

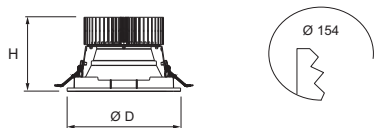

R3 PTR 54 LED 2

W	T° Amb	Ø D	H	Kg
19	-20°C +35°C	216	116	0,90
24	-20°C +35°C	216	116	0,90

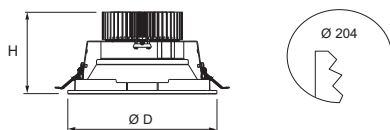

R3 PTR 54 LED 3

W	T° Amb	Ø D	H	Kg
28	-20°C +35°C	266	139	1,10
32	-20°C +35°C	266	139	1,10

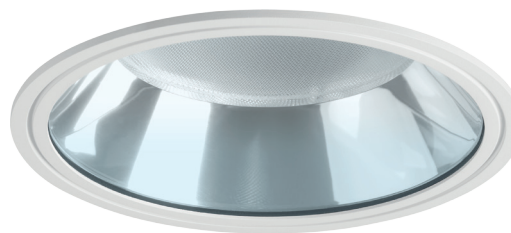
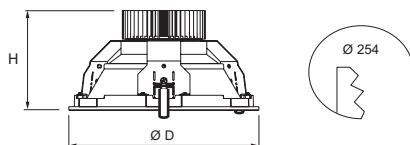

Antes de proceder al montaje, desconecte la corriente eléctrica! La luminaria ha de ser conectada solamente por la persona que posee la calificación adecuada. La luminaria ha de ser conectada solamente en conformidad con las normas electrotécnicas correspondientes. En caso que el producto fuera modificado o instalado incorrectamente, el fabricante no asume responsabilidad alguna.

Turn off the power prior to light fixture installation!. The light fixture may be installed only by a qualified person!.The light fixture must be wired according to respective electrical standards. Use protective gloves when handling the reflective part!. The manufacturer shall not be liable for any modifications or incorrect installation of the product.

Luminaria empotrada adecuada para el montaje en superficie normalmente inflamable. Bajo ninguna circunstancia, la luminaria debe cubrirse con material aislante o similar.

Recessed luminaire suitable for mounting on flammable surfaces. Under no circumstances, the luminaire should be covered with insulating material or similar.

Reemplazar el cristal de protección en caso de agrietado o rotura.

Replace the protective glass in case of cracked or broken.

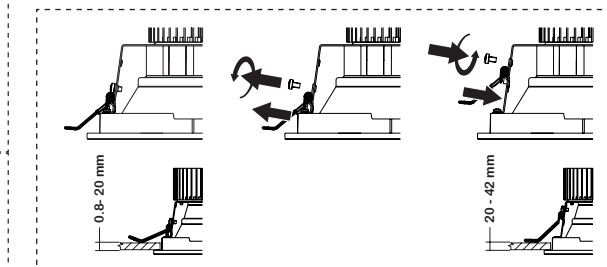
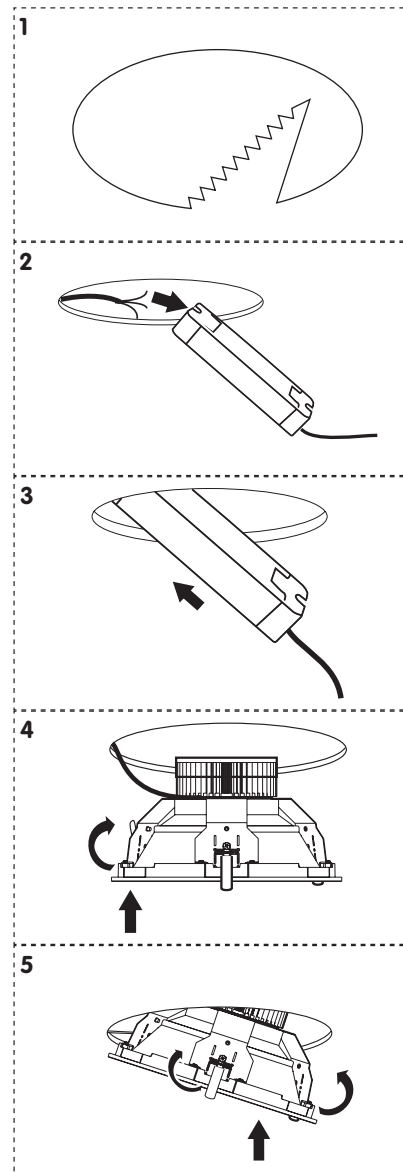
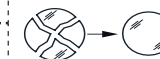

Esquema eléctrico Electric diagram

