

## DO RX ECO LED



### DO RX ECO LED 12

W	T° Amb	L	A	H	Kg
27	< +35°C	1196	296	52	4,40
37	< +35°C	1196	296	52	4,40

### DO RX ECO LED 21

W	T° Amb	L	A	H	Kg
33	< +35°C	596	596	52	3,60

### DO RX ECO LED 41

W	T° Amb	L	A	H	Kg
27	< +35°C	596	596	52	3,60
37	< +35°C	596	596	52	3,60

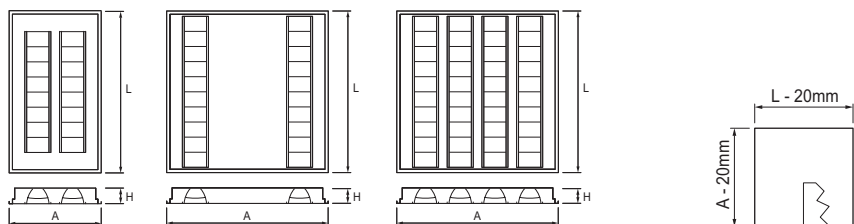

#### Esquema eléctrico Electric diagram

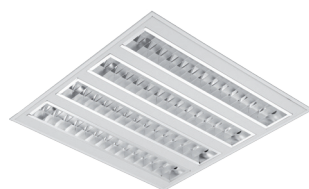
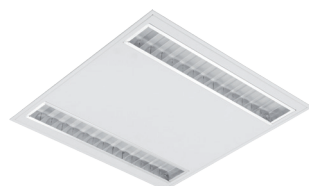
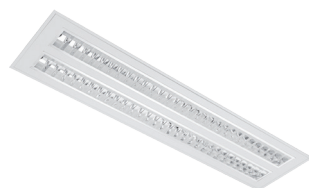
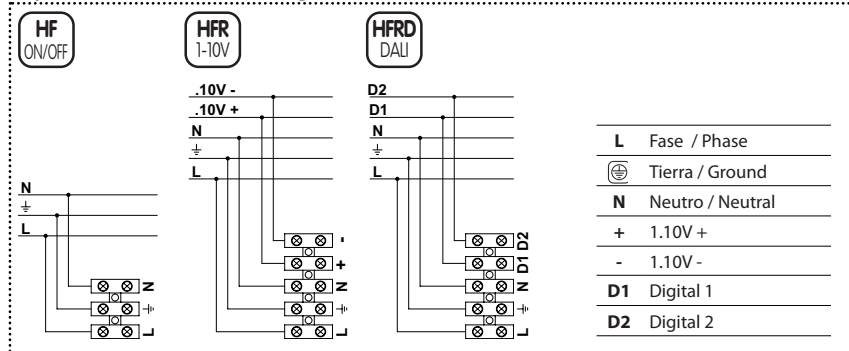

Antes de proceder al montaje, desconecte la corriente eléctrica! La luminaria ha de ser conectada solamente por la persona que posee la calificación adecuada. La luminaria ha de ser conectada solamente en conformidad con las normas electrotécnicas correspondientes. En caso que el producto fuera modificado o instalado incorrectamente, el fabricante no asume responsabilidad alguna.

Turn off the power prior to light fixture installation!. The light fixture may be installed only by a qualified person!.The light fixture must be wired according to respective electrical standards. Use protective gloves when handling the reflective part!. The manufacturer shall not be liable for any modifications or incorrect installation of the product.



Luminaria empotrada adecuada para el montaje en superficie normalmente inflamable. Bajo ninguna circunstancia, la luminaria debe cubrirse con material aislante o similar.

Recessed luminaire suitable for mounting on flammable surfaces. Under no circumstances, the luminaire should be covered with insulating material or similar.

### DO RX ECO LED PB

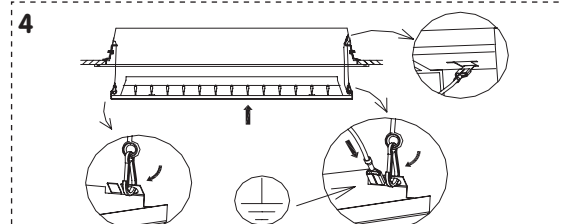
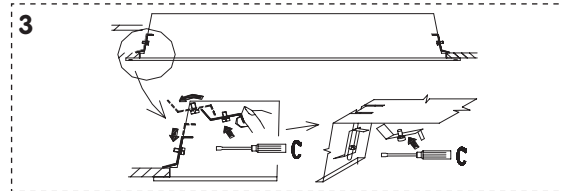
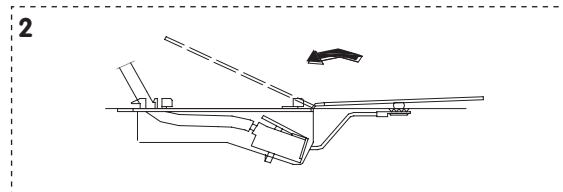
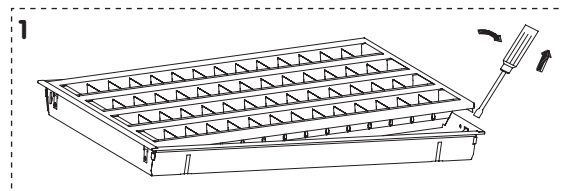

### DO RX ECO LED TPV

